

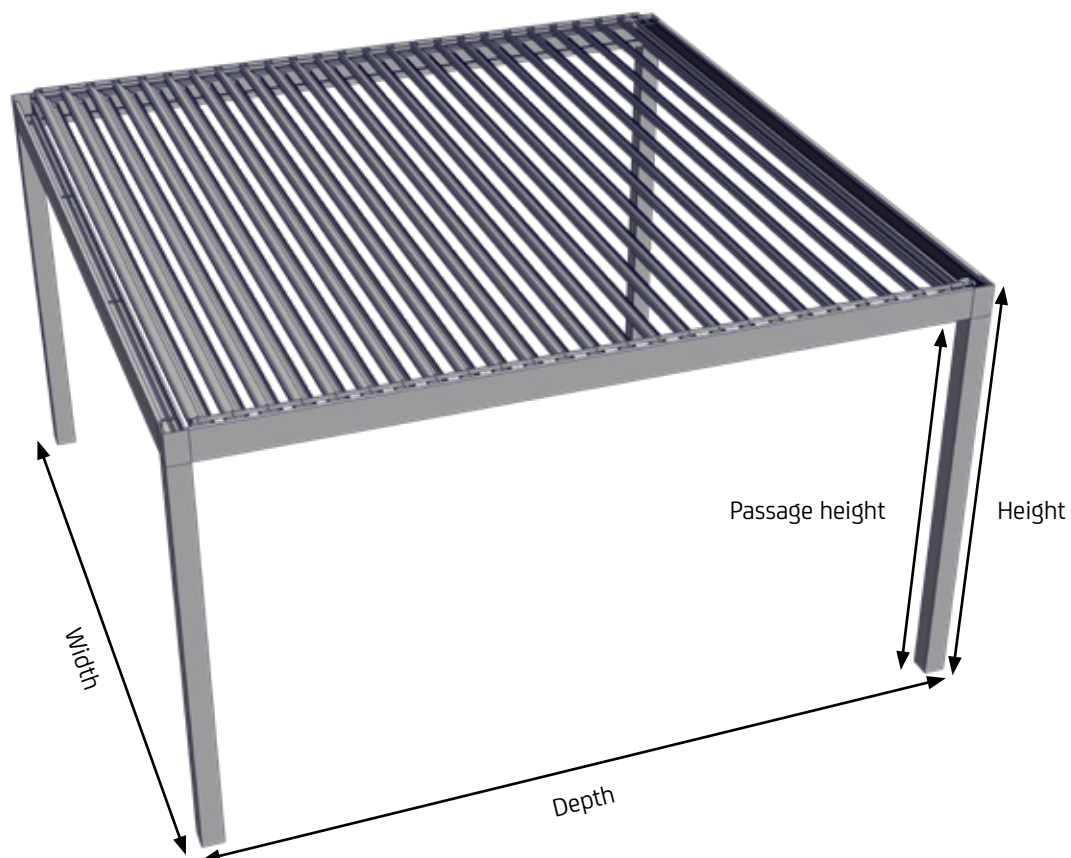

Altera® Dimensions

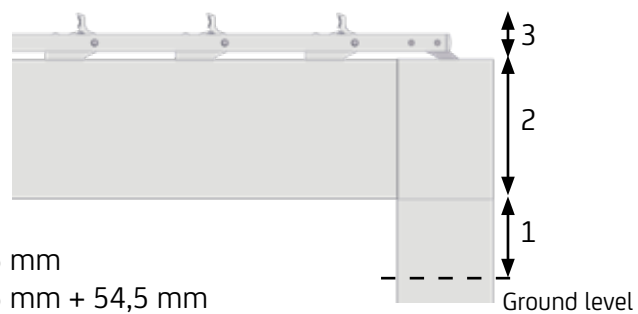

Width:	Max. 4000 mm
Depth:	Max. 3979 mm
Passage height (1):	Max. 2800 mm
Total height (1+2):	Passage height + 160,5 mm
Rotation height (1+2+3):	Passage height + 160,5 mm + 54,5 mm



Fixed depth dimensions









10 slats:	1729 mm	16 slats:	2629 mm	21 slats:	3379 mm
11 slats:	1879 mm	17 slats:	2779 mm	22 slats:	3529 mm
12 slats:	2029 mm	18 slats:	2929 mm	23 slats:	3679 mm
13 slats:	2179 mm	19 slats:	3079 mm	24 slats:	3829 mm
14 slats:	2329 mm	20 slats:	3229 mm	25 slats:	3979 mm

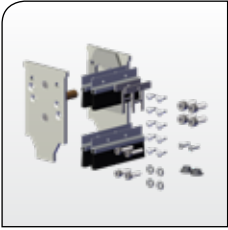

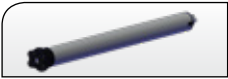



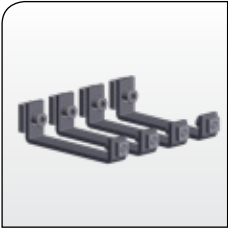
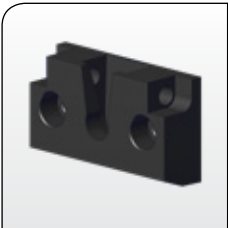





* The slats of the Altera can be mounted in any width and depth for every possible installation for optimal sun protection / regulation

= Article will be sold out. Special orders remain possible.



Partnummer	Description	Paint finish	Length in m ¹ Pack. Unit
	4409 196-068 Spare parts kit motor- and bearing side (incl. fixing material)		
	4409 160-068 Drive rod kit		
	4000 645-000 Motor Altera 44NM 4RPM with black cable 5 m (Geiger)		
	4000 647-000 Motor adapter Altera tube 63		
	4000 648-068 Friction ring motor Altera roller 63		
	4452 225-068 Nylon Bearing bung roller 63 incl. bearing with increased inner ring		
	4409 169-068 Bracket kit (kit 4 pieces) for fixing the end profile (NOT motorside)		
	4409 150-905 Nylon slat holder	Black	
	4217 185-000 Stainless steel socket-head bolt M6 x 16 mm cylinder (For fixing the slat holder on fastening strip)		50

= Article will be sold out. Special orders remain possible.

	Partnummer	Description	Paint finish	Length in m ¹ Pack. Unit
	4000 243-000	Tension pin 34 x 6 mm for securing the slat in the holder		50
	4409 190-000	Button head screw M8 x 20 mm (for fixing the end cap slat to operating rod)		100
	4409 171-000	Nylon ring 14 x 8.3 x 3 mm (For fixing end cap of the slat to operating rod)	White	
	4409 174-905	Nylon spacer (For fixing end cap of the slat to the operating rod)	Black	
	4210 142-000	Plate screw countersunk Philips head 4.2 x 32 mm (For fixing end cap to the slat)		100
	4217 280-000	Socket-head adjusting screw M8 x 50 mm stainless steel (For fixing support beams to the corner sections)		50
	4000 226-000	Stainless steel nut M8 (For fixing support beams to the corner sections)		50
	4410 400-000	Socket-head bolt cylinder screw M8 x 30 mm (For fixing the supports to the corner sections)		50
	4452 093-000	Stainless steel washer M8 (For fixing support beams and supports to the corner sections)		100
	4600 392-000	Selfdrilling screw 4.2 x 25 mm AISI410 (For fixing end profiles to the support beams and end cap motor side)		100

= Article will be sold out. Special orders remain possible.



Partnummer	Description	Paint finish	Length in m ¹ Pack. Unit
------------	-------------	--------------	--

Basic parts color dependent

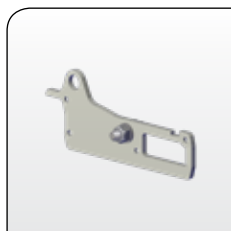

4409 141-090	End plate slat left	Mill finish	
4409 141-006	Idem	RAL 9010 pure white	
4409 141-755	Idem (* = textured)	RAL 7016 anthracitegrey*	

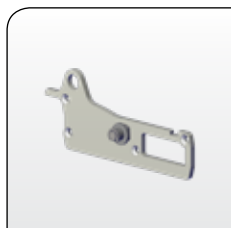

4409 143-090	End plate slat right	Mill finish	
4409 143-006	Idem	RAL 9010 pure white	
4409 143-755	Idem (* = textured)	RAL 7016 anthracitegrey*	

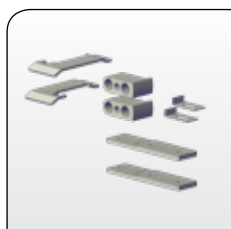

4409 198-090	Spare parts kit Altera consists of: 2 x Filling blocks operating rod bracket 2 x Filling plate motor/bearing support 2 x End plate operating rod 2 x Cover plates water cap (1x left and 1 x right)	Mill finish	
4409 198-006	Idem	RAL 9010 pure white	
4409 198-755	Idem (* = textured)	RAL 7016 anthracitegrey*	

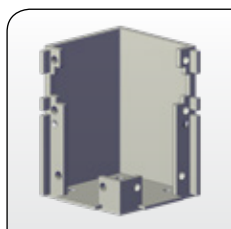

4409 130-090	Alu corner section for support and support beams WITHOUT water drainage	Mill finish	
4409 130-006	Idem	RAL 9010 pure white	
4409 130-755	Idem (* = textured)	RAL 7016 anthracitegrey*	

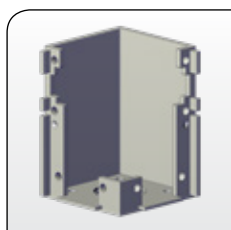

4409 132-090	Alu corner section for support and support beams WITH water drainage	Mill finish	
4409 132-006	Idem	RAL 9010 pure white	
4409 132-755	Idem (* = textured)	RAL 7016 anthracitegrey*	

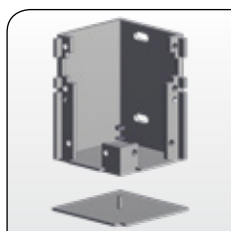

4409 135-090	Alu corner section wallmounting with cover plates, left WITHOUT water drainage	Mill finish	
4409 135-006	Idem	RAL 9010 pure white	
4409 135-755	Idem (* = textured)	RAL 7016 anthracitegrey*	

= Article will be sold out. Special orders remain possible.

Partnummer	Description	Paint finish	Length in m ¹ Pack. Unit
4409 137-090	Alu corner section wallmounting with cover plates, right WITHOUT water drainage	Mill finish	
4409 137-006	Idem	RAL 9010 pure white	
4409 137-755	Idem (* = textured)	RAL 7016 anthracitegrey*	

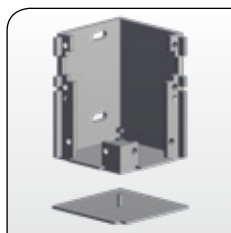

All aluminium sections for a linked Altera see page 12.

Basic length material

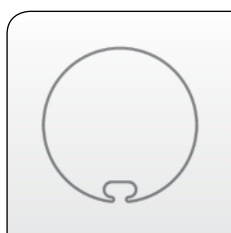

6253 011-000	Steel tube 63 x 0,9 mm	Zinc-plated	3,91
6253 005-000	Idem	Zinc-plated	6,0
6253 006-000	Idem	Zinc-plated	7,0
6253 007-000	Idem	Zinc-plated	7,5



4409 181-001	Fastening strip for slat holders	Silver anodized	3,84
--------------	----------------------------------	-----------------	------



4409 201-000	Rubber sealing for slats Roll 110 m. is enough for Altera with 25 slats		110
4409 203-000	Rubber sealing for slats		300

= Article will be sold out. Special orders remain possible.



Partnummer	Description	Paint finish	Length in m ¹ Pack. Unit
------------	-------------	--------------	--

Basic length material color dependent

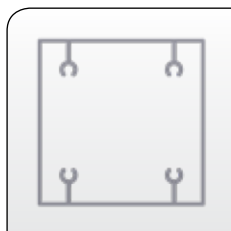

6300 055-000	Post	Mill finish	6,0
6300 056-000	Idem	Mill finish	6,5
6300 055-006	Idem	RAL 9010 pure white	6,0
6300 056-006	Idem	RAL 9010 pure white	6,5
6300 055-755	Idem (* = textured)	RAL 7016 anthracitegrey*	6,0
6300 056-755	Idem (* = textured)	RAL 7016 anthracitegrey*	6,5

Length 6 meters will be replaced by length 5.7 m when sold out.

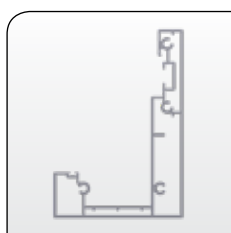

6300 062-000	Support beam	Mill finish	3,9
6300 062-006	Idem	RAL 9010 pure white	3,9
6300 062-755	Idem (* = textured)	RAL 7016 anthracitegrey*	3,9



6300 072-000	End profile motor side	Mill finish	4,05
6300 072-006	Idem	RAL 9010 pure white	4,05
6300 072-755	Idem (* = textured)	RAL 7016 anthracitegrey*	4,05

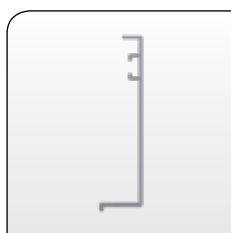

6300 102-000	End profile not motor side	Mill finish	4,05
6300 102-006	Idem	RAL 9010 pure white	4,05
6300 102-755	Idem (* = textured)	RAL 7016 anthracitegrey*	4,05

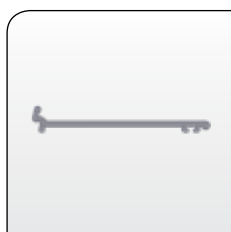

6295 980-000	Cover profile motor side	Mill finish	4,0
6295 984-000	Idem	Mill finish	5,0
6295 988-000	Idem	Mill finish	6,0
6295 980-006	Cover profile motor side	RAL 9010 pure white	4,0
6295 984-006	Idem	RAL 9010 pure white	5,0
6295 988-006	Idem	RAL 9010 pure white	6,0
6295 980-755	Cover profile motor side (* = textured)	RAL 7016 anthracitegrey*	4,0
6295 984-755	Idem	RAL 7016 anthracitegrey*	5,0
6295 988-755	Idem	RAL 7016 anthracitegrey*	6,0

= Article will be sold out. Special orders remain possible.









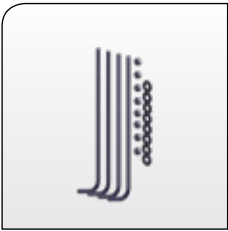
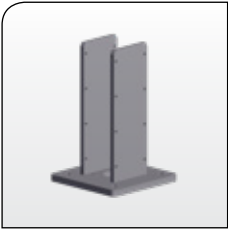

Partnummer	Description	Paint finish	Length in m ¹ Pack. Unit
6300 082-000	Slat	Mill finish	4,02
6300 082-951	Idem	RAL 9010 pure white MAT	4,02
6300 082-755	Idem (* = textured)	RAL 7016 anthracitegrey*	4,02

**On order, the slat is also available in RAL 9010 with a standard gloss (same as the posts and support beams).
The article number is then 6300 082-006.**

4409 179-090	Operating rod for slats	Mill finish	3,73
4409 179-006	Idem	RAL 9010 pure white	3,73
4409 179-755	Idem (* = textured)	RAL 7016 anthracitegrey*	3,73

= Article will be sold out. Special orders remain possible.

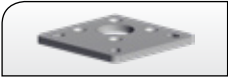

Partnummer	Description	Paint finish	Length in m ¹ Pack. Unit
	4217 240-000 Spiral flute machine tap M8, to make thread in post and in support beam		
	4409 233-000 Alu positioning plate for threaded ends 4409 193-068		
	4409 193-068 Set of 4 curved threaded ends with mounting material. For attaching base plates (4409 189/184/185) into concrete foundation.		
	4409 189-000 Steel base plate post (for freestanding mounting and also for wallmounting)	Zinc-plated	
	4217 077-000 Stud bolt M8 x 30 mm stainless steel (For fixing the bottomside of the base plate 4409 189 to the post)		100
	4210 931-000 Stud bolt M8 x 16 mm stainless steel (For fixing the post to the structure plates of the base plate 4409 189)		100
	4452 093-000 Stainless steel washer M8		100
	4409 220-000 Drilling template for base plate 4409 189		
	4409 184-090 Alu base plate (only suitable for fixing post when wallmounted)	Mill finish	
	4409 184-006 Idem	RAL 9010 pure white	
	4409 184-755 Idem (* = textured)	RAL 7016 anthracitegrey*	
	4409 185-090 Alu base plate Only suitable for fixing posts in a corner or for wallmounting	Mill finish	
	4409 185-006 Idem	RAL 9010 pure white	
	4409 185-755 Idem (* = textured)	RAL 7016 anthracitegrey*	
	4210 063-000 Socket-head bolt M8 x 30 mm stainless steel (For fixing the base plate 4409 184 or 4409 185 to the post)		50

= Article will be sold out. Special orders remain possible.

Partnummer	Description	Paint finish	Length in m ¹ Pack. Unit
4409 208-068	Pvc collar piece 50 mm		
4409 225-000	Double solvent socket 50 mm. (For fixing the collar piece to the pvc-tube 50 mm)	Grey	
4409 229-000	Pvc-tube 50 mm		3,5
4409 228-000	Pvc knee 50 mm 90° socket-spigot With water drainage through the side of the post	Grey	
4409 230-068	Pvc ring black for fixing pvc-knee 4409-228-000 to the post (incl. fixing material)		
4409 202-000	Stainless steel finishing plate for recess at the bottom of the support for water drainage in combination with baseplate 4409 184 or 4409 185 (Fastening screws selfdrilling in set 4409 196-068)		
4409 210-000	Leaf catcher for corner section and connector section for joint Altera with water drainage		

= Article will be sold out. Special orders remain possible.



Partnummer	Description	Paint finish	Length in m ¹ Pack. Unit
7700 306-000	Self-drilling drill screw 4,2 x 13 mm AISI410 (For fixing Leaf catcher)		100



If passage height is lower than 250 cm, fix the corner profile below as pinch protection on the sides where the drive rod is installed or completely around

1203 270-000	Corner profile 30 x 20 x 2 mm	Mill finish	6,0
1203 270-006	Idem	RAL 9010 pure white	6,0
1203 270-755	Idem (* = textured)	RAL 7016 anthracitegrey*	6,0

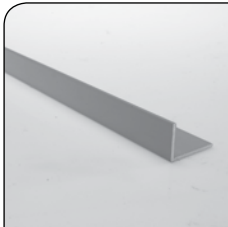

Parts for linked version

4409 127-090	Alu corner section for linked Altera with cover plates WITHOUT water drainage (incl. fixing material)	Mill finish
4409 127-006	Idem	RAL 9010 pure white
4409 127-755	Idem (* = textured)	RAL 7016 anthracitegrey*

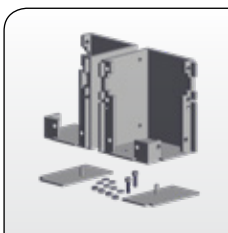

4409 126-090	Alu corner section for linked Altera with cover plates WITH water drainage (incl. fixing material)	Mill finish
4409 126-006	Idem	RAL 9010 pure white
4409 126-755	Idem (* = textured)	RAL 7016 anthracitegrey*

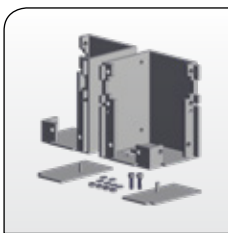

4409 213-068	Nylon water drainage funnel with fixing material for alu corner section for linked Altera with hole for water drainage (4409 126-...) when a pvc-tube is connected to it
--------------	--



Electric options

5755 245-000	Cable welding box 40 x 75 x 37 mm (H x W x L) IP54
--------------	--

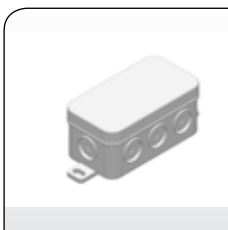

4409 218-090	Alu profile kit incl. fixing material for mounting and covering distribution box or other optional electrical items (1 per unit) incl. fixing material	Mill finish
4409 218-006	Idem	RAL 9010 pure white
4409 218-755	Idem (* = textured)	RAL 7016 anthracitegrey*

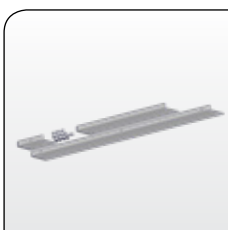

= Article will be sold out. Special orders remain possible.

Partnummer	Description	Paint finish	Length in m ¹ Pack. Unit
------------	-------------	--------------	--

Below are several options for controlling the Altera motor.

Somfy operations



4001 478-000 Somfy SLIM io receiver for the Altera motor
(with pergola icon)

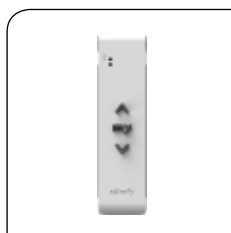

4001 631-000 Somfy Situio 1 io



4001 635-000 Somfy Situio 5 io



5754 105-000 Somfy Situio 5 VAR A/M io
(also suitable for future LED-lighting)



4000 972-000 Somfy Connexoon io



4001 654-000 Somfy Eolis io wind sensor
(also needed for section rain sensor)

= Article will be sold out. Special orders remain possible.



Partnummer	Description	Paint finish	Length in m ¹ Pack. Unit
------------	-------------	--------------	--



4001 343-000 Somfy Ondeis rain sensor



4001 655-000 Somfy Thermis io (frost protection)

Note: can not directly on the Somfy SLIM io receiver. To be used together with the Connexoon io.

Teleco operation



5755 247-000 Teleco operating basic-set (TVALL)



5755 242-000 Teleco rain sensor



5755 244-000 Teleco hand transmitter
(also suitable for future LED-lighting)

More Teleco controls will soon be added to our assortment.

= Article will be sold out. Special orders remain possible.